

1) TOOL TYPE - GERAETETYP - DESCRIZIONE MACCHINA - TYPE D'OUTIL - TIPO DE MAQUINA
 cod. 11328 FA 32-15/18

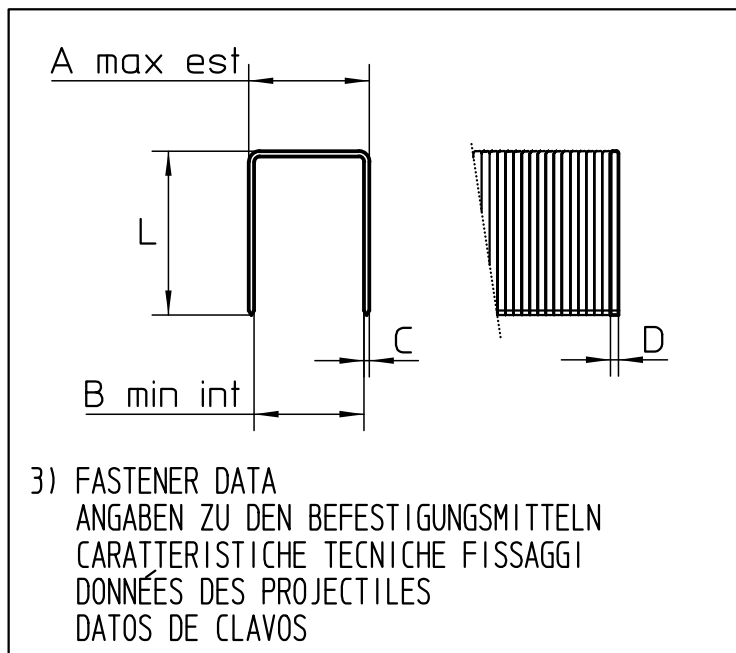
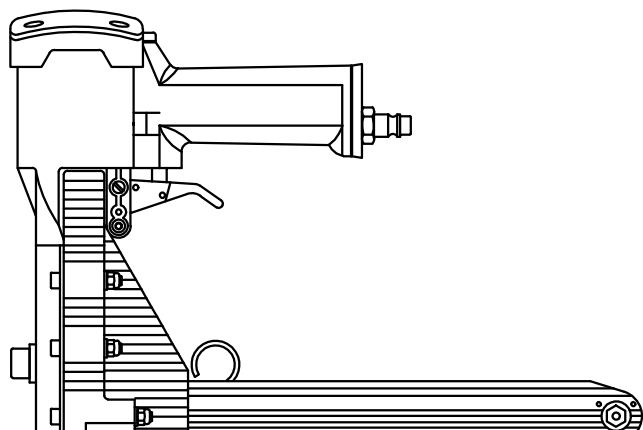

2) TOOL CHARACTERISTICS
 SPEZIFICATION DES GERAETES
 CARATTERISTICHE TECNICHE
 CARACTÉRISTIQUES DE L'OUTIL
 CARACTERÍSTICAS DE LA MAQUINA

HEIGHT HOEHE ALTEZZA HAUTEUR ALTURA	WIDTH BREITE LARGHEZZA LARGEUR ANCHURA	LENGTH LAENGE LUNGHEZZA LONGUEUR LONGITUD	WEIGHT GEWICHT PESO POIDS PESO
in.8.66 mm.220	in.4.72 mm.120	in.13.40 mm.340	lbs.4.60 kg.2.090
MIN-MAX WORKING PRESSURE MIN-MAX ARBEITSDRUCK MIN-MAX PRESSIONE DI ESERCIZIO MIN-MAX PRESSION DE TRAVAIL MIN-MAX PRESSION DE TRABAJO		70 / 100 psi 5 / 7 BAR	
AIR CONSUMPTION PER CYCLE LUFTVERBRAUCH PRO NAGELUNG CONSUMO ARIA PER COLPO CONSOMMATION DE L'AIRE PAR COUP CONSUMO DE AIRE CADA DISPARO		PERFORMANCES AT 90 psi (0.62 MPa) PRESTAZIONI A 6.2 BAR (0.62 MPa) 0.018 SCF 0.51 L.	
LUBRICANT SCHMIEROEL LUBRIFICANTE LUBRIFIANT LUBRIFICANTE		AEROSPACE LUBRICANTS TRIBOLUBE 12	

3) FASTENER DATA
 ANGABEN ZU DEN BEFESTIGUNGSMITTELN
 CARATTERISTICHE TECNICHE FISSAGGI
 DONNÉES DES PROJECTILES
 DATOS DE CLAVOS

A) OUTSIDE CROWN AUSSEN RUECKEN LARGHEZZA EST. CORONNE EXT. CORONA EXT.	MAX	in. 1.260 mm. 32.00
B) INSIDE CROWN INNEN RUECKEN LARGHEZZA INT. CORONNE INT. CORONA INT.	MIN	in. 1.189 mm. 30.20
CxD) WIRE DRAHT FILO FIL ALAMBRE		in. 0.035 x 0.077 mm. 0.90 x 1.95
L) LENGTH LAENGE LUNGHEZZA LONGUEUR LONGITUD	MIN-MAX	in. 5/8" - 3/4" mm. 15 - 18
MAGAZINE CAPACITY MAGAZIN CAPAZITAET CAPACITA' CARICATORE CAPACITE' CHARGEUR CAPACIDAD CARGADOR		100 staples

* ACTUATION SYSTEM * AUSLOESEART * ATTUAZIONE * MISE EN OEUVRE * ACTUACIÓN	5 (SAFETY : NO)
--	-----------------

* LOADING	BOTTOM LOADING
* LADEN	SIDE LOADING
* CARICAMENTO	● TOP LOADING
* CHARGER	COIL
* CARGA	OTHER

* SEE INSTRUCTION MANUAL - SIEHE BETRIEBSANLEITUNG - VEDI MANUALE - VOIR MODE D'EMPLOI - VER EL MANUAL

NOISE CHARACTERISTICS GERÄUSCH - EMISSION DATEN CARATTERISTICHE RUMOROSITA' CARACTÉRISTIQUES ACOUSTIQUE CARACTERÍSTICAS DE RUIDO	EN 12549+A1:2008	$L_{WA,1s}$, :93.00 dB(A) - $K_{WA,1s}$, 2.5
	EN ISO 4871:2009	$L_{pA,1s}$, :80.00 dB(A) - $K_{pA,1s}$, 2.5

VIBRATION VALUE VIBRATIONSWERT VALORE DI VIBRAZIONE VALEUR DE VIBRATION VALOR DE VIBRACIÓN	UNI ISO/TS 8662-11	IS BELOW THE DECLARATION LIMIT SET BY LIEGT UNTER DEM ANZUGEBENEN WERT GEMÄSS RISULTA AL DI SOTTO DEL LIMITE DA DICHI. STABILITO IN RESULTA AU DESSOUS DE LA LIMITE A DECLARER ETABLIE PAR RESULTA SER DEBAJO DEL LIMITE A DECLARAR	UNI EN ISO 12100-1/2
--	-----------------------	---	-------------------------